

MENTOR

RESEARCH IN MOTION CONFIDENTIAL

HIERARCHICAL BLOCK		COPYRIGHT 2008, RESEARCH IN MOTION LIMITED	
MAIN		295 PHILLIP ST.	
DRAWN BY Brad LaFlamme		WATERLOO, ONTARIO, CANADA	
R&D CHECK		PHONE: (519) 888-7465, FAX (519) 888-6306	
VFG CHECK		TITLE	
Edi Led Bu: blafamme		Javelin - ArgonLV - Main Board	
Level: Ed14: Sep 19, 2008, 10:39:28 am		(Uses: PCB-17810-006)	
SIZE		DRAWING NO. SCH-17811-006	
C		REV D	
		SHEET 1 OF 17	

COPIED FROM POP-17811-005 REV. D ON JULY 25/08

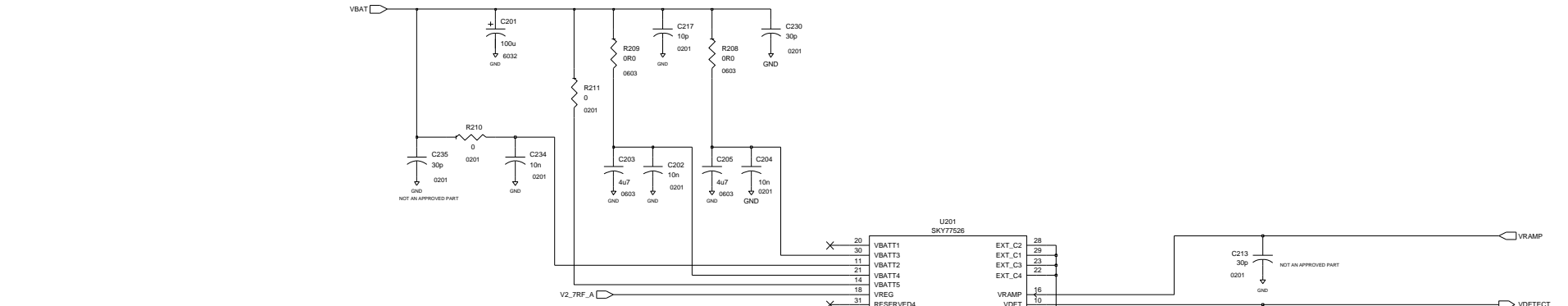

(850/900/1800/1900 MHz)
GSM850/GSM900/DCS1800/PCS1900 ANTENNA

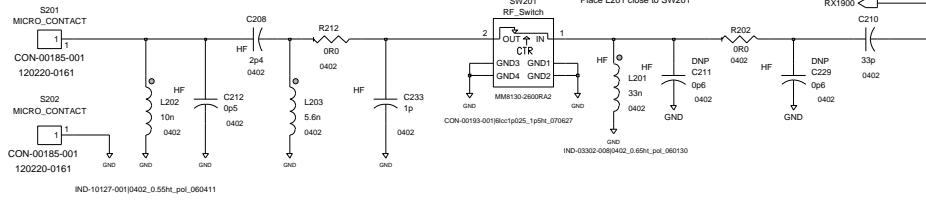

FOR TEST PURPOSES ONLY

BLUETOOTH ANTENNA

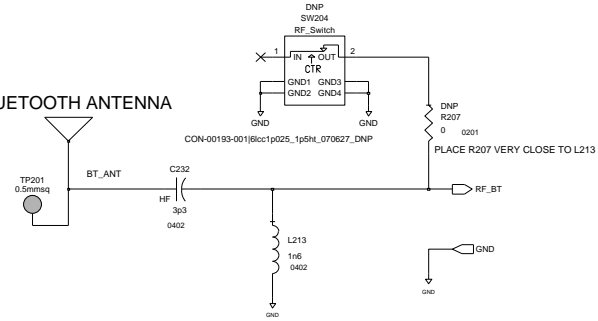

GPS/WIFI ANTENNA
COAX CONNECTOR + CLIPS

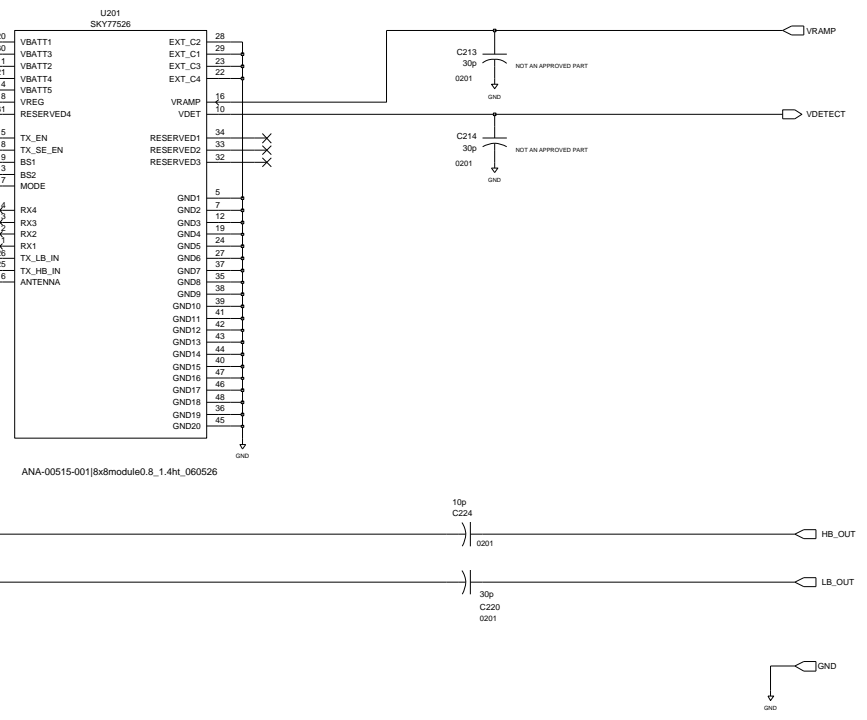
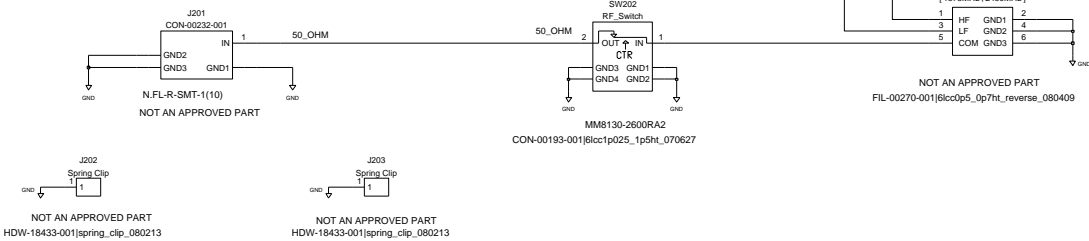

GPS

WLAN
2.4GHz 802.11b/g

RESEARCH IN MOTION CONFIDENTIAL

HIERARCHICAL BLOCK RF_ANT	COPYRIGHT 2008, RESEARCH IN MOTION LIMITED 295 PHILLIP ST. WATERLOO, ONTARIO, CANADA PHONE: (519) 888-7465, FAX (519) 888-6306
DRAWN BY Brad LaFlamme	TITLE Javelin - ArgonLV - Main Board
R&D CHECK	(uses: PCB-17810-006)
HFG CHECK	SIZE DRAWING No. SCH-17811-006
Edi Led By: blflamm	C REV D SHEET 2 OF 17
Last Ed: 1 Sep 18, 2008, 1:06:58 pm	

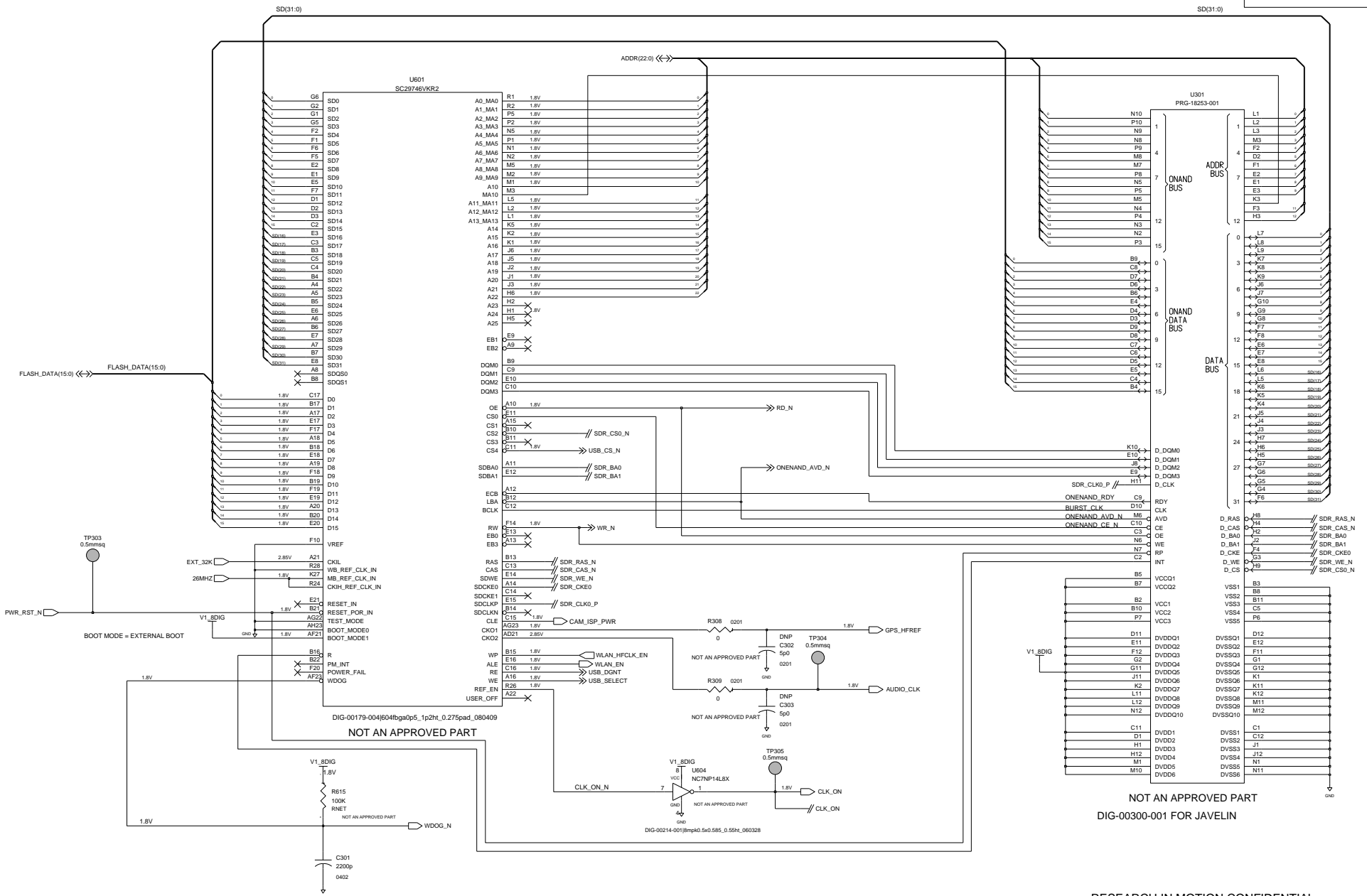

RESEARCH IN MOTION CONFIDENTIAL

HIERARCHICAL BLOCK PROCESSOR2		COPYRIGHT 2008, RESEARCH IN MOTION LIMITED 295 PHILLIP ST. WATERLOO, ONTARIO, CANADA PHONE: (519) 888-7465, FAX (519) 888-6306	
DRAWN BY Brad LaFlamme		TITLE Javelin - ArgonLV - Main Board	
R&D CHECK		(uses: PCB-17810-006)	
MFG CHECK		SIZE DRAWING No. SCH-17811-006	
Edi Led Bu: blaflamm		REV D	
Last Ed1: Sep 18, 2008, 1:13:39 pm		SHEET 3 OF 17	

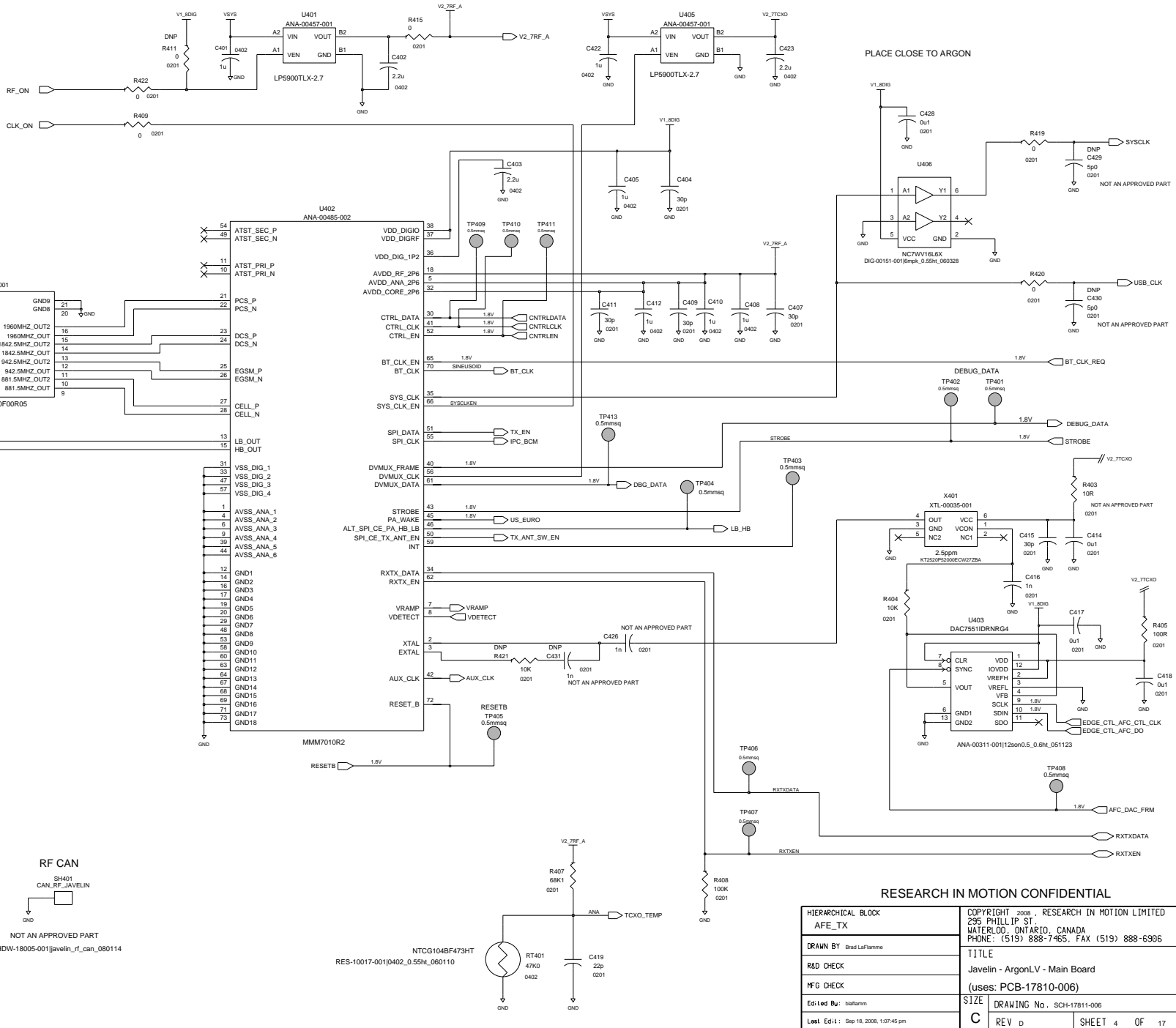

PLACE CLOSE TO ARGON

DEBUG_DATA

RESEARCH IN MOTION CONFIDENTIAL

HIERARCHICAL BLOCK AFE_TX		COPYRIGHT 2008, RESEARCH IN MOTION LIMITED 295 PHILLIP ST. WATERLOO, ONTARIO, CANADA PHONE: (519) 888-7465, FAX (519) 888-6306	
DRAWN BY Brad LaFlamme		TITLE Javelin - ArgonLV - Main Board	
R&D CHECK		(uses: PCB-17810-006)	
IFG CHECK		SIZE C	
Edi Led Bu: blaflamme		DRAWING No. SCH-17811-006	
Last Ed: 1: Sep 18, 2008, 1:07:45 pm		REV D SHEET 4 OF 17	

SPARE GATES



DIG-00214-001@p04604bga0p5_1p2ht_0.275pad_080409
NOT AN APPROVED PART

DIGITAL CAN



HDW-18007-001@javelin_digital_can_080114
NOT AN APPROVED PART

U601 SC29746VKR2

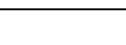
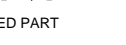
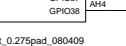
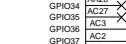
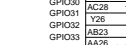
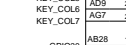
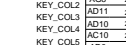
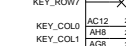
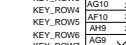
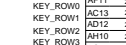
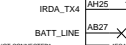
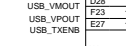
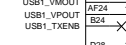
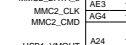
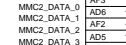
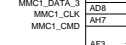
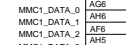
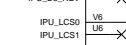
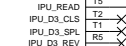
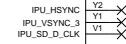
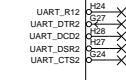
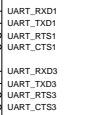
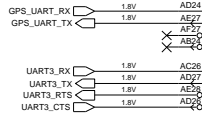

DIG-00179-004@604bga0p5_1p2ht_0.275pad_080409

NOT AN APPROVED PART

JTAG PORT

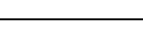
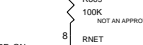
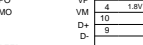
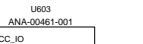

U601 SC29746VKR2

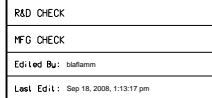
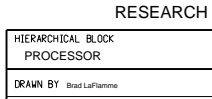
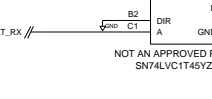
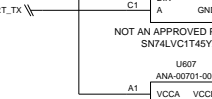
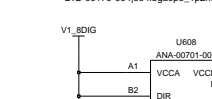
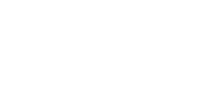
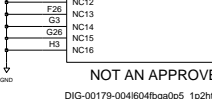
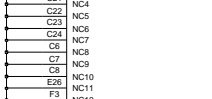
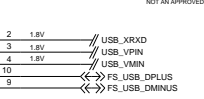
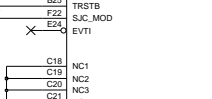
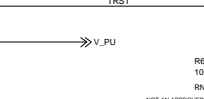
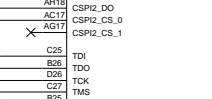
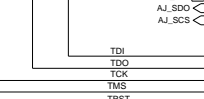
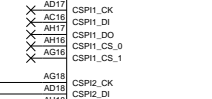
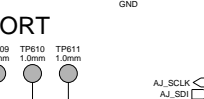
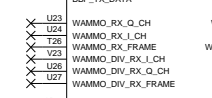
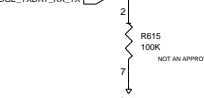
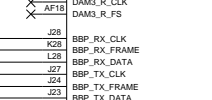
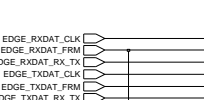
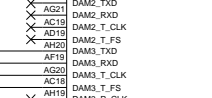
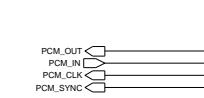
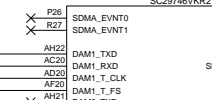
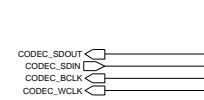

NOT AN APPROVED PART

DIG-00179-004@604bga0p5_1p2ht_0.275pad_080409

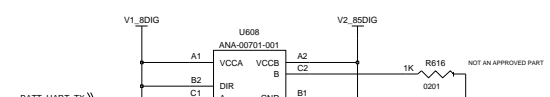

NOT AN APPROVED PART

DIG-00179-004@604bga0p5_1p2ht_0.275pad_080409

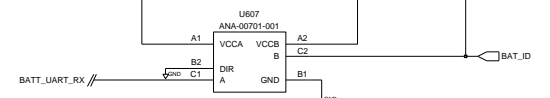

RESEARCH IN MOTION CONFIDENTIAL

HIERARCHICAL BLOCK PROCESSOR		COPYRIGHT 2008, RESEARCH IN MOTION LIMITED 295 PHILLIP ST. WATERLOO, ONTARIO, CANADA PHONE: (519) 888-7465, FAX (519) 888-6306	
DRAWN BY: Brad LaFlamme	R&D CHECK	TITLE Javelin - ArgonLV - Main Board	
IFG CHECK	Eci Led Bu: blaflam	(uses: PCB-17810-006)	
Label Ed1: Sep 18, 2008, 1:13:17 pm	SIZE: C	DRAWING No. SCH-17811-006	SHEET 6 OF 17

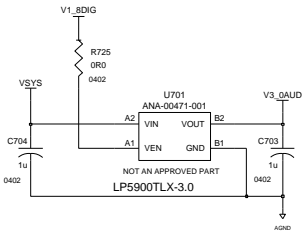

To Daughter Card Connector

***** IMPORTANT *****
AUDIO: PLEASE MAKE MIC PADS GOLD PLATED

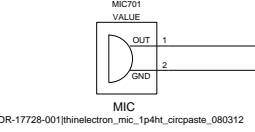
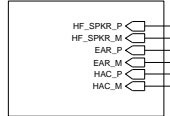

To Daughter Card Connector

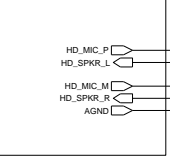

AUDIO CAN

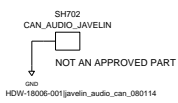

MIC CAN

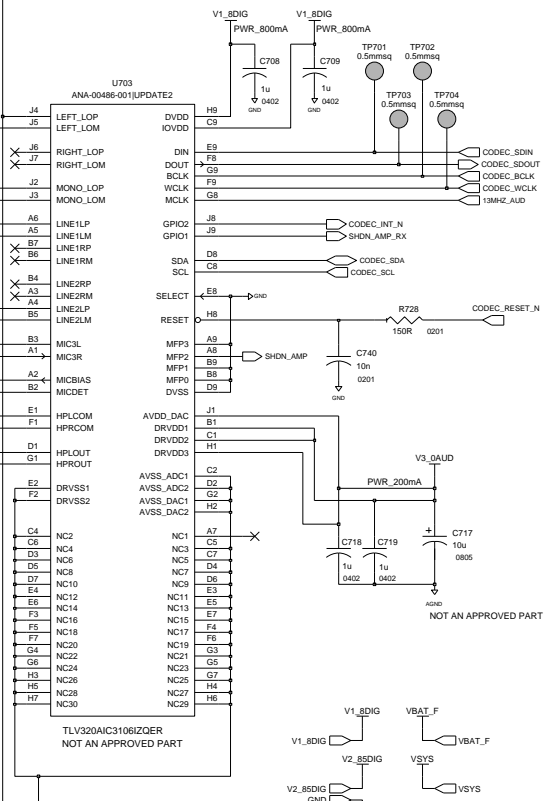
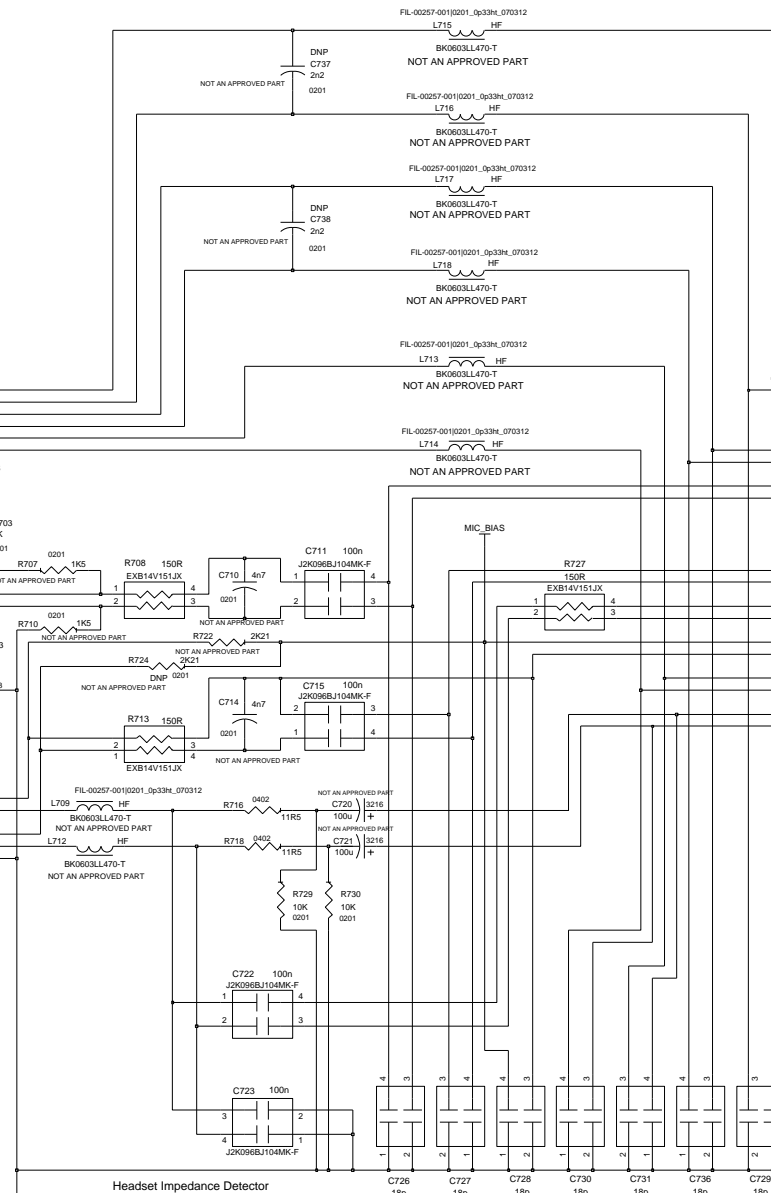
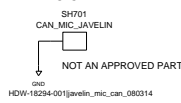

RESEARCH IN MOTION CONFIDENTIAL

HIERARCHICAL BLOCK AUDIO		COPYRIGHT 2008, RESEARCH IN MOTION LIMITED 295 PHILLIP ST. WATERLOO, ONTARIO, CANADA PHONE: (519) 888-7465, FAX (519) 888-6306	
DRAWN BY Brad LaFlamme		TITLE Javelin - ArgonLV - Main Board	
R&D CHECK		(uses: PCB-17810-006)	
MFG CHECK		SIZE	
Edi Led By: blafamm		DRAWING No. SCH-17811-006	
Level Ed1: Sep 18, 2008, 1:08:39 pm		REV D	
		SHEET 7 OF 17	

TO AUDIO/CAMERA FLEX

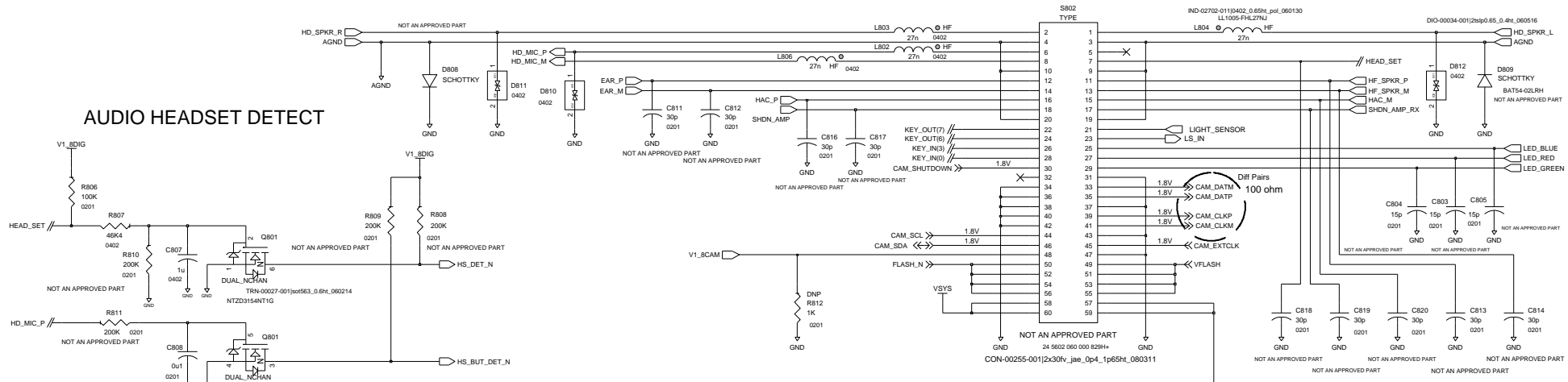

AUDIO HEADSET DETECT

MECHANICAL JOG BALL - MJB

JOG BALL INTERFACE

ATOMIC JOG BALL - AJB

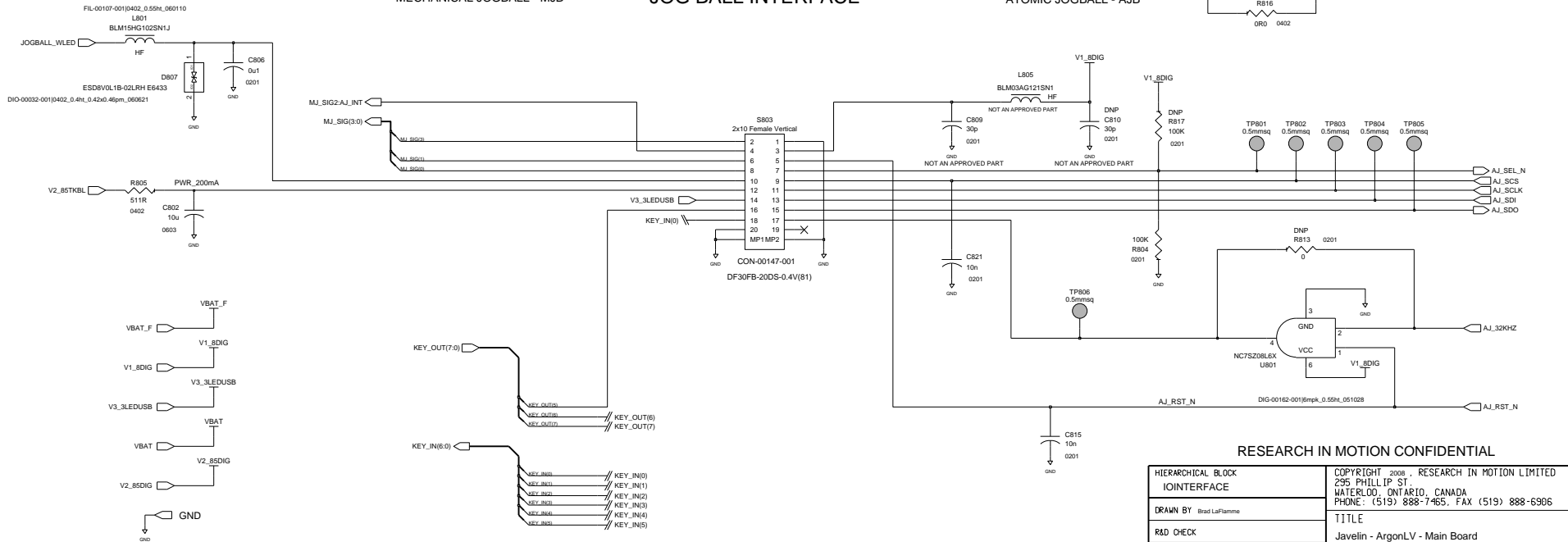

RESEARCH IN MOTION CONFIDENTIAL

HIERARCHICAL BLOCK JOINTERFACE		COPYRIGHT 2008, RESEARCH IN MOTION LIMITED 295 PHILLIP ST. WATERLOO, ONTARIO, CANADA PHONE: (519) 888-7465, FAX (519) 888-6306	
DRAWN BY Brad LaFlamme		TITLE Javelin - ArgonLV - Main Board	
R&D CHECK		(uses: PCB-17810-006)	
MFG CHECK		SIZE DRAWING No. SCH-17811-006	
Edi Led Bu: blafamme		C	
Level Ed1: Sep 18, 2008, 1:11:03 pm		REV D	SHEET 8 OF 17

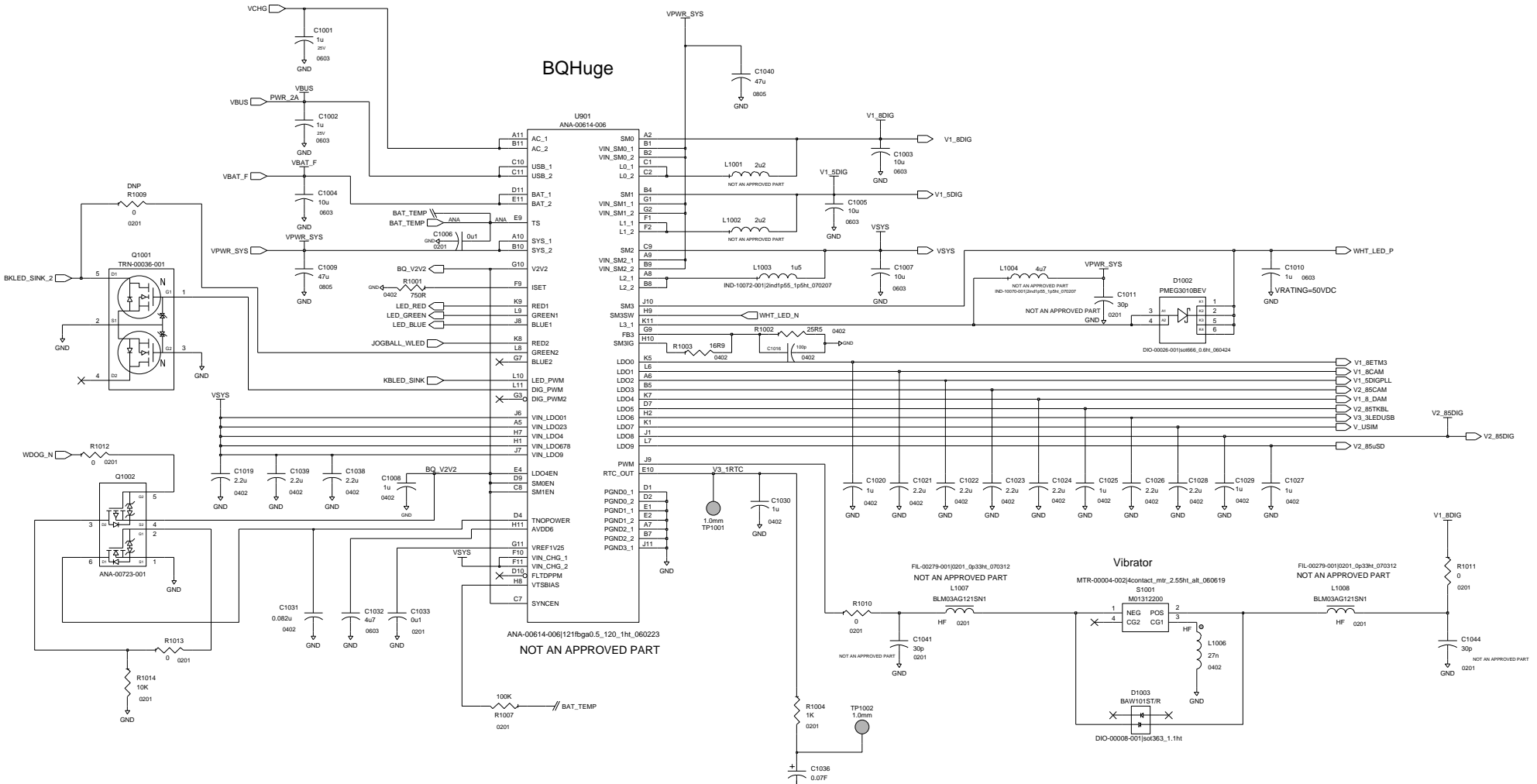

WARNING EXPLOSIVE
 FOLLOW MANUFACTURERS
 ASSEMBLY/REWORK INSTRUCTIONS
 DISCHARGE BEFORE REWORK
 DO NOT OVERHEAT

RESEARCH IN MOTION CONFIDENTIAL

HIERARCHICAL BLOCK POWER		COPYRIGHT 2008, RESEARCH IN MOTION LIMITED 295 PHILLIP ST. WATERLOO, ONTARIO, CANADA PHONE: (519) 888-7465, FAX (519) 888-6306	
DRAWN BY Brad LaFlamme		TITLE Javelin - ArgonLV - Main Board	
R&D CHECK		(uses: PCB-17810-006)	
MFG CHECK		SIZE DRAWING No. SCH-17811-006	
Edi Led By: blafamm		C REV D SHEET 10 OF 17	
Last Ed1: Sep 18, 2008, 1:08:09 pm			

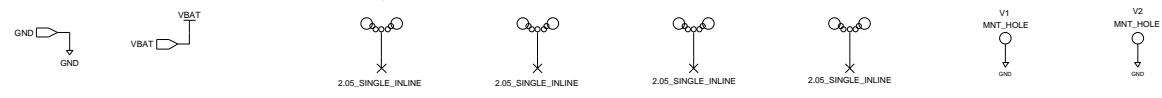

OPTIS LCD CONNECTOR

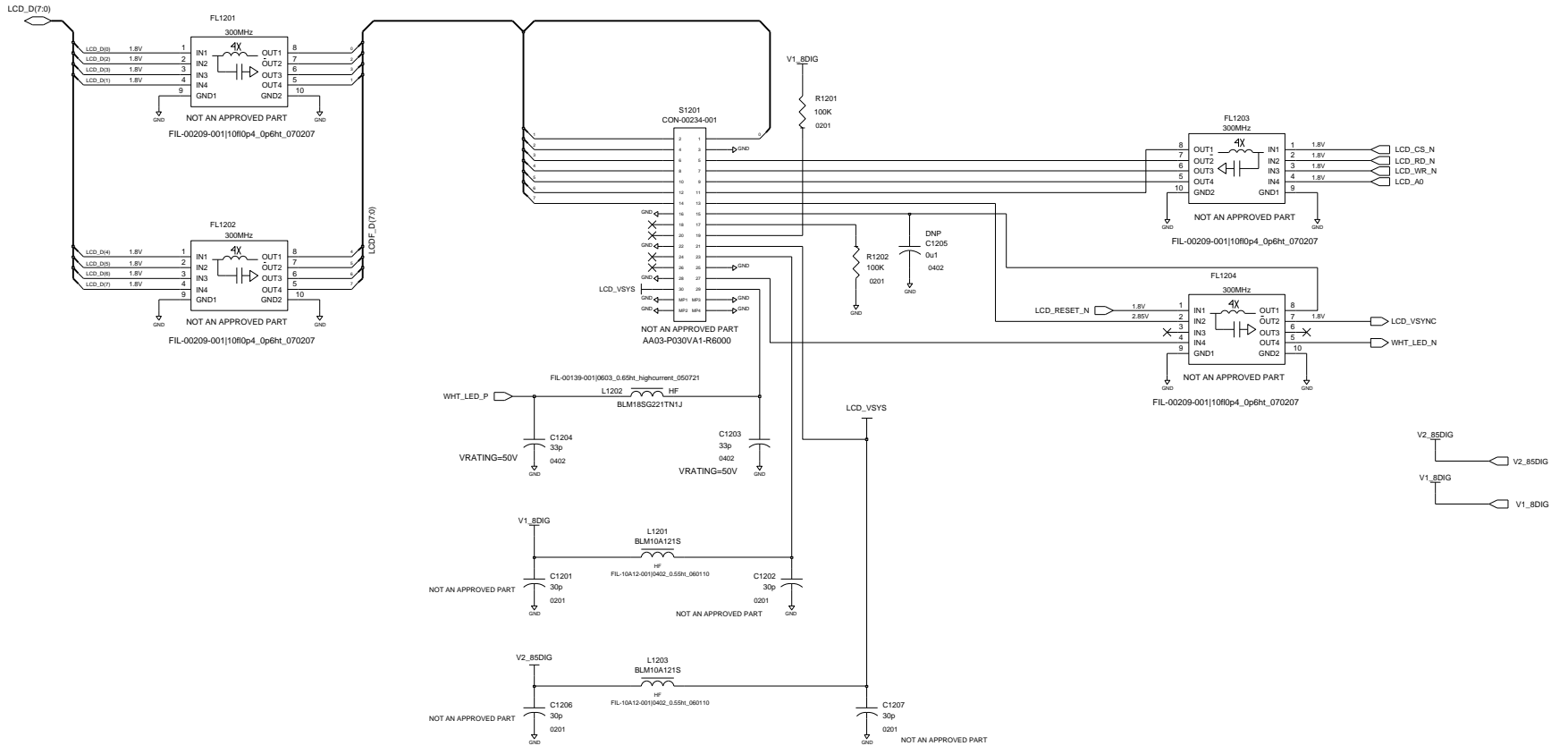

RESEARCH IN MOTION CONFIDENTIAL

HIERARCHICAL BLOCK JOINTERFACE2		COPYRIGHT 2008, RESEARCH IN MOTION LIMITED 295 PHILLIP ST. WATERLOO, ONTARIO, CANADA PHONE: (519) 888-7465, FAX (519) 888-6306	
DRAWN BY Brad LaFlamme		TITLE Javelin - ArgonLV - Main Board	
R&D CHECK		(uses: PCB-17810-006)	
MFG CHECK		DRAWING No. SCH-17811-006	
Edi Led By: blaflam		SIZE C	
Last Edt: Sep 18, 2008, 1:11:58 pm		REV D SHEET 12 OF 17	

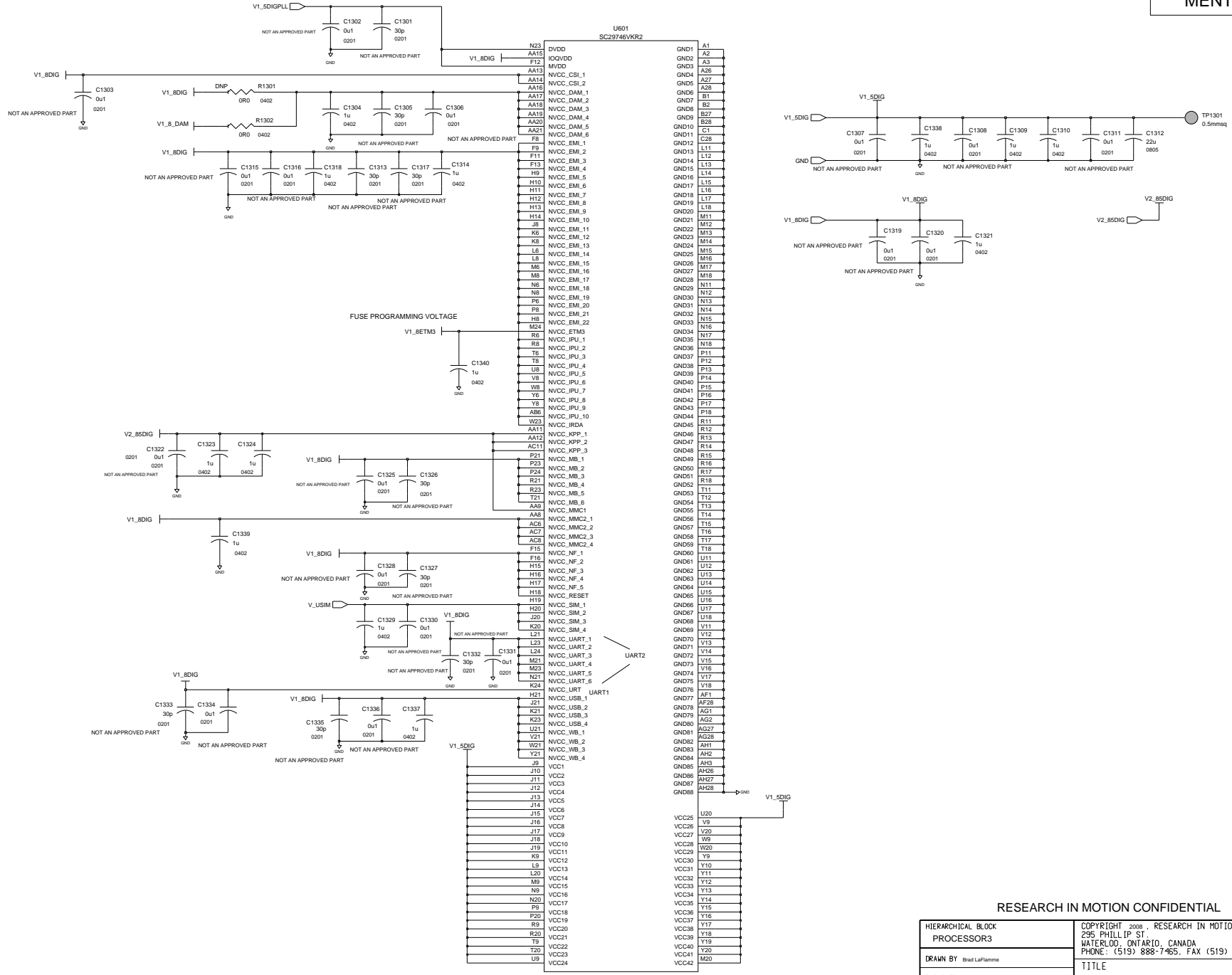

RESEARCH IN MOTION CONFIDENTIAL

HIERARCHICAL BLOCK PROCESSORS3		COPYRIGHT 2008, RESEARCH IN MOTION LIMITED 295 PHILLIP ST. WATERLOO, ONTARIO, CANADA PHONE: (519) 888-7465, FAX (519) 888-6306	
DRAWN BY: Brad LaFlamme		TITLE: Javelin - ArgonLV - Main Board	
R&D CHECK:		(uses: PCB-17810-006)	
IFG CHECK:		SIZE: DRAWING No. SCH-17811-006	
Edi Led By: blaflamm		C REV D SHEET 13 OF 17	
Last Ed1: Sep 18, 2008, 11:42:19 am			

DIG-00179-004f604bga0p5_1p2ht_0.275pad_080409

NOT AN APPROVED PART

HS-USB CONTROLLER

CHARGE/USB CONNECTOR

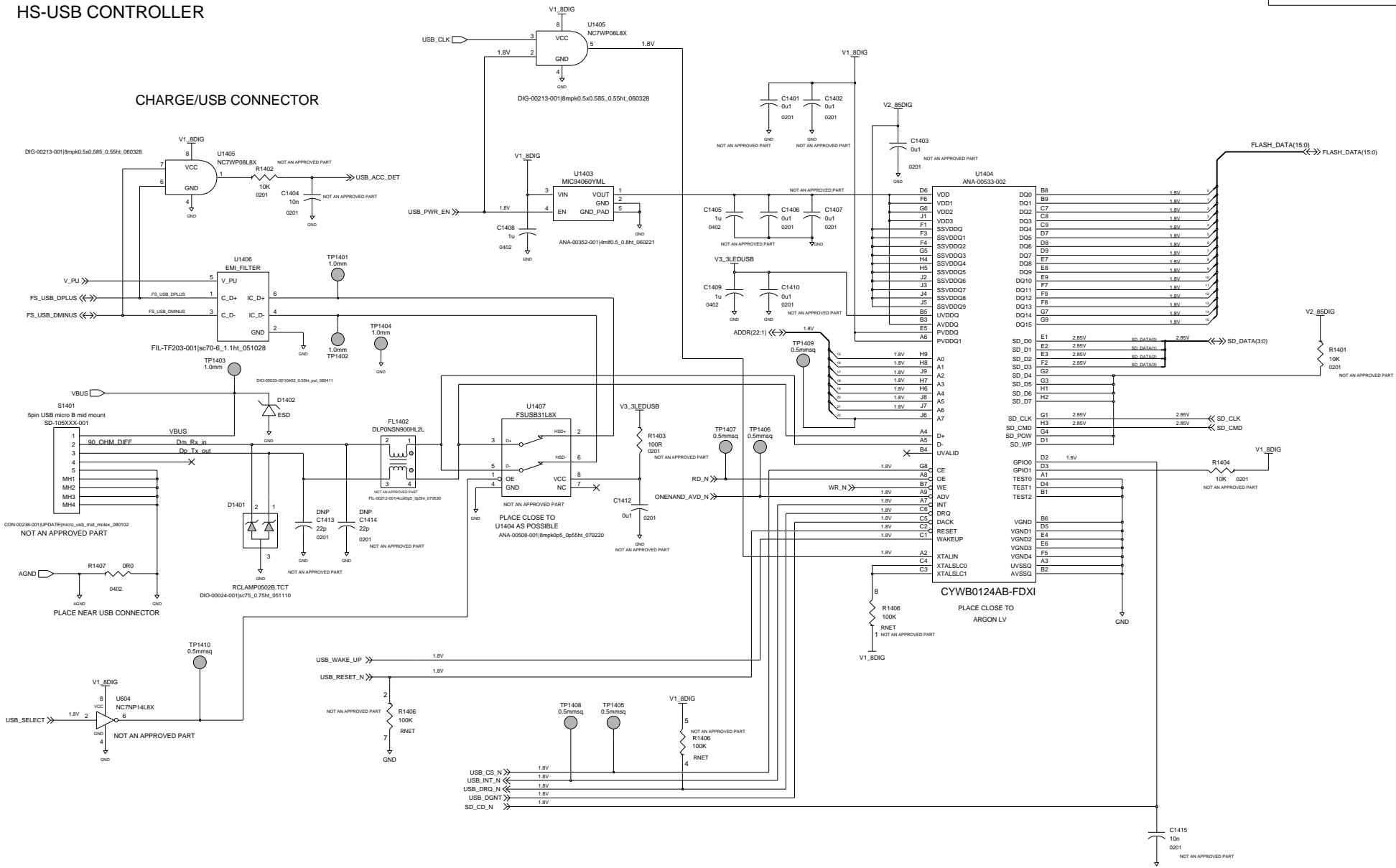

SPARE

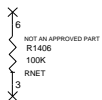

RESEARCH IN MOTION CONFIDENTIAL

HIERARCHICAL BLOCK PROCESSOR4	COPYRIGHT 2008, RESEARCH IN MOTION LIMITED 295 PHILLIP ST. WATERLOO, ONTARIO, CANADA PHONE: (519) 888-7465, FAX (519) 888-6306
DRAWN BY Brad LaFlamme	TITLE Javelin - ArgonLV - Main Board
R&D CHECK	(uses: PCB-17810-006)
Edi Led By: blafamm	SIZE DRAWING No. SCH-17811-006
Level Ed1: Sep 18, 2008, 1:13:28 pm	C REV D SHEET 14 OF 17

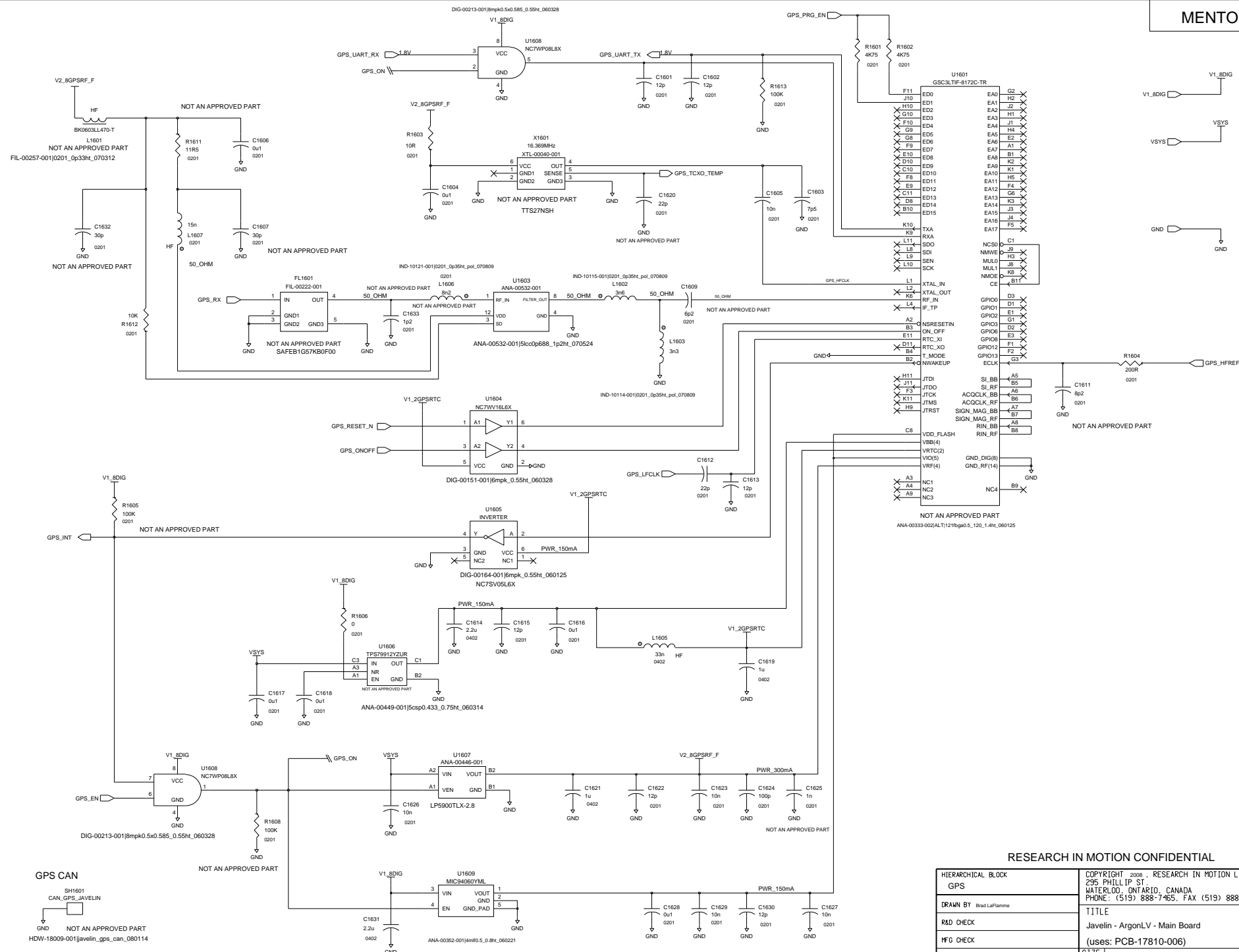

RESEARCH IN MOTION CONFIDENTIAL

HIERARCHICAL BLOCK		COPYRIGHT 2008, RESEARCH IN MOTION LIMITED	
GPS		295 PHILLIP ST.	
DRAWN BY Brad LaFlamme		WATERLOO, ONTARIO, CANADA	
R&D CHECK		PHONE: (519) 888-7465, FAX (519) 888-6306	
HFG CHECK		TITLE	
Edi Led Bu: blafamm		Javelin - ArgonLV - Main Board	
Last: Ed1: Sep 18, 2008, 1:07:30 pm		(uses: PCB-17810-006)	
SIZE		DRAWING No. SCH-17811-006	
REV D		SHEET 16 OF 17	

